

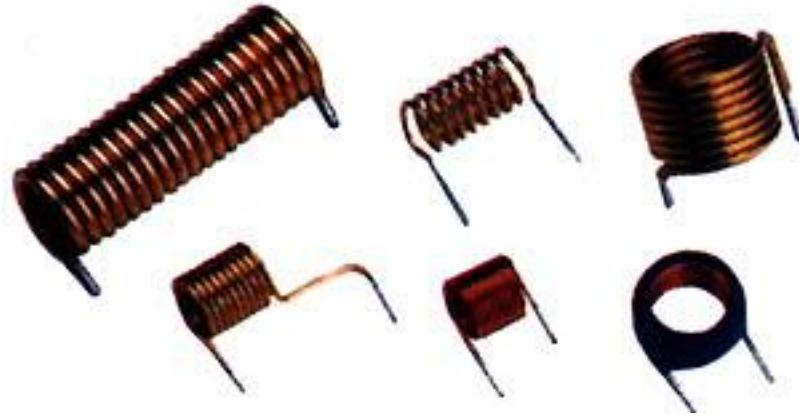

CALLE 9 No 22-08 Cali WhatsApp 3146408487 - 5570525

Web. www.systemcaraudio.wix.com/academia Email orlismun@yahoo.es

MODULO 2 REPARACION PLANTAS
CAR AUDIO



TO-92 (Plastic)

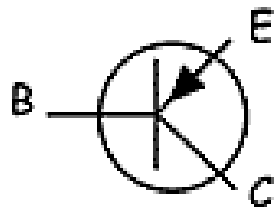
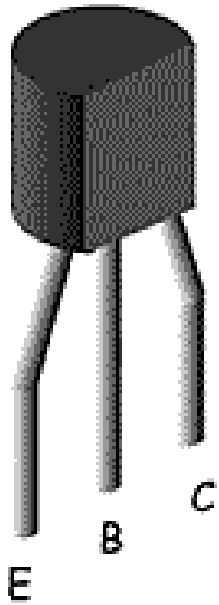

PNP Like 2N3906

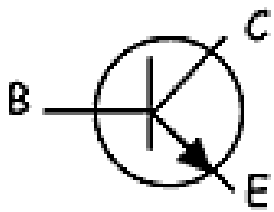

NPN Like 2N3904

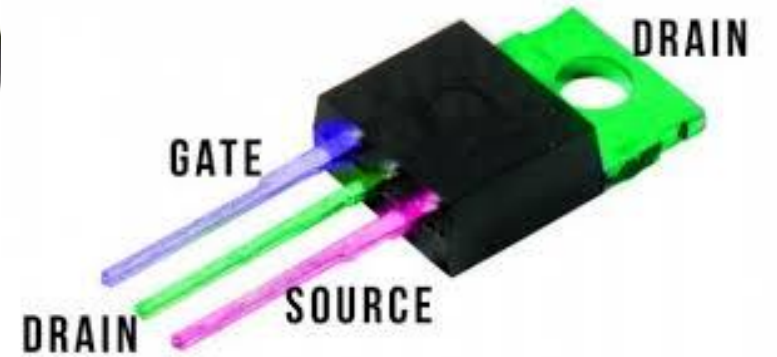
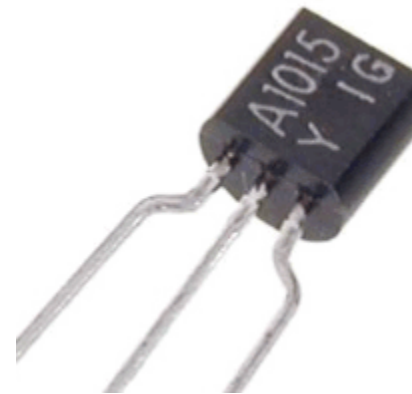

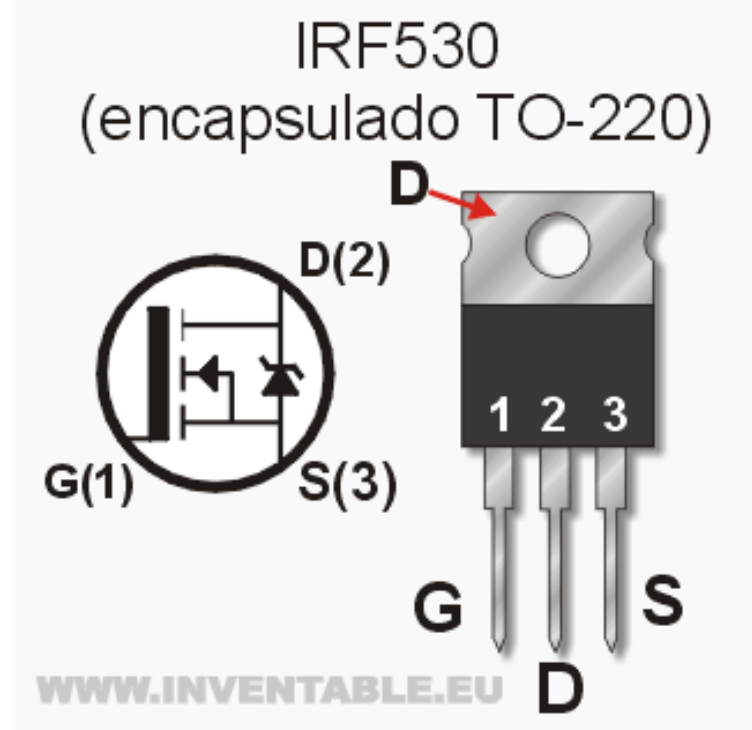
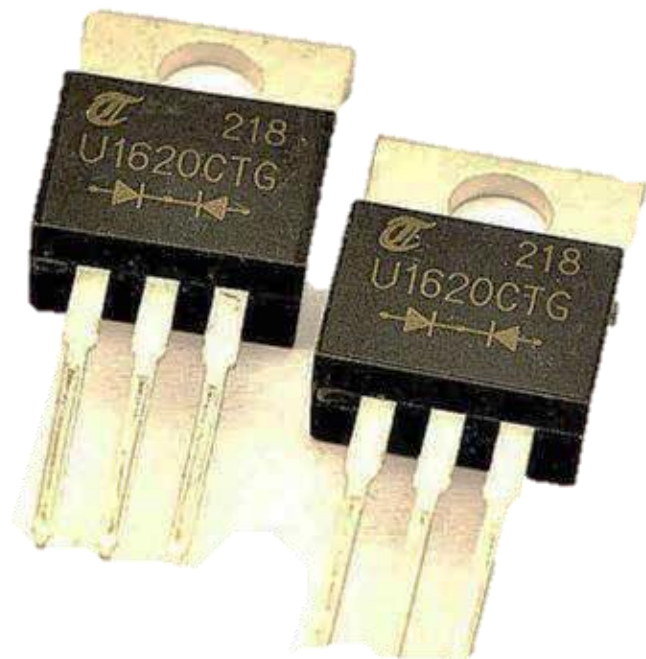
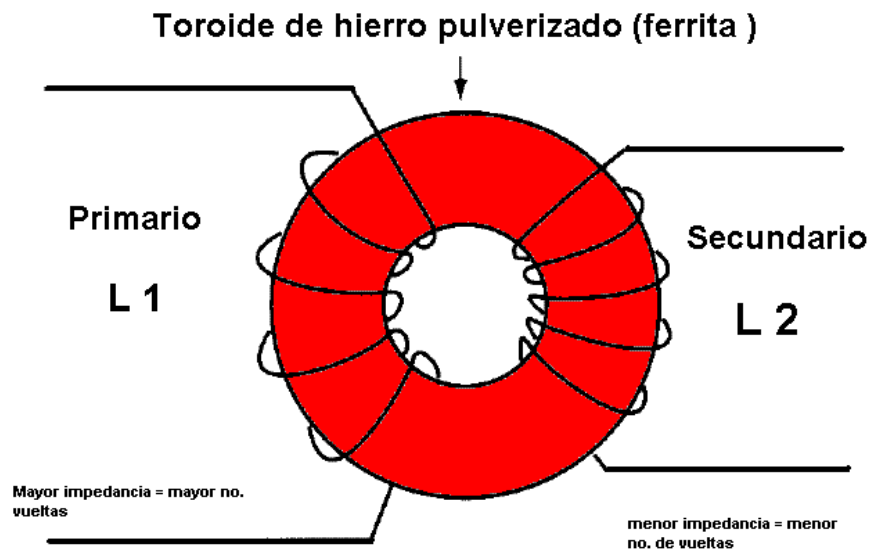

N-channel

P-channel

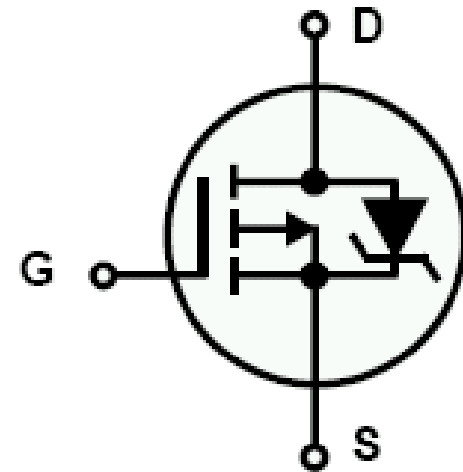
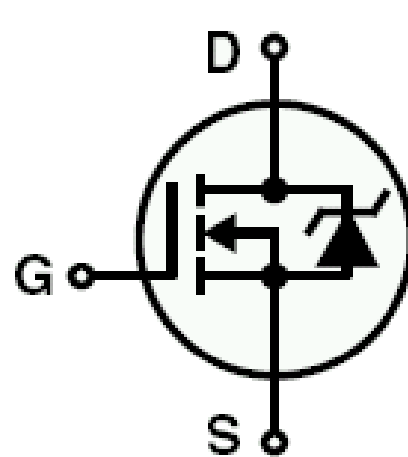

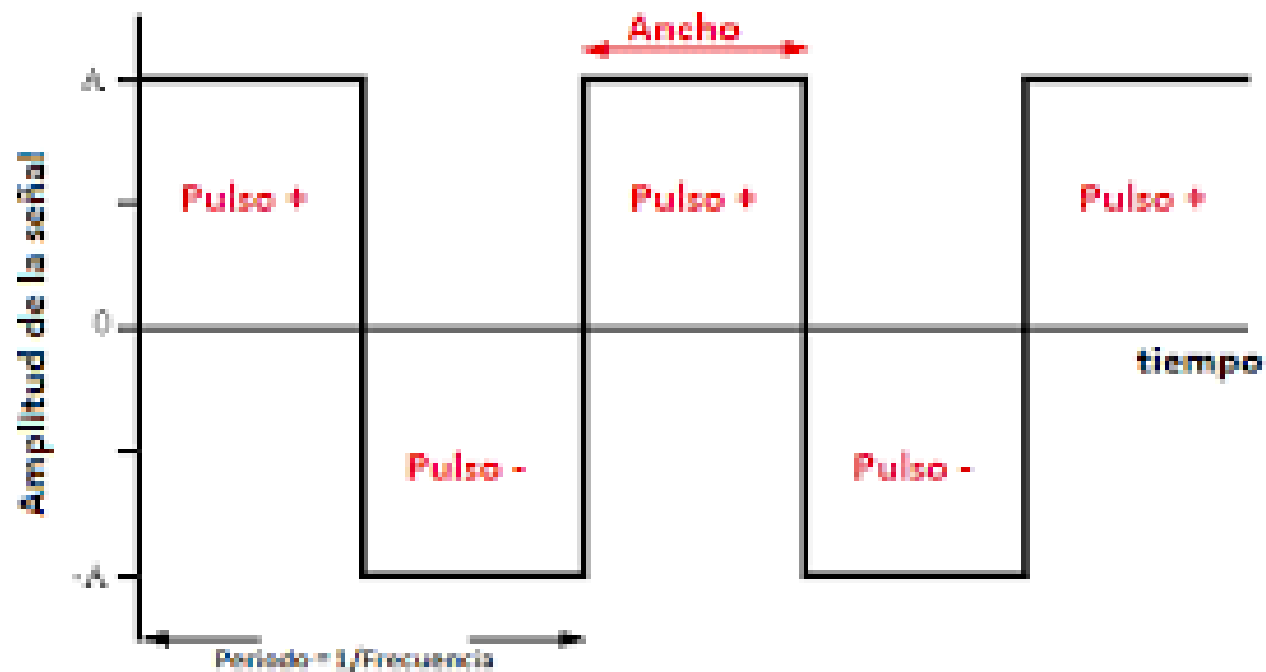
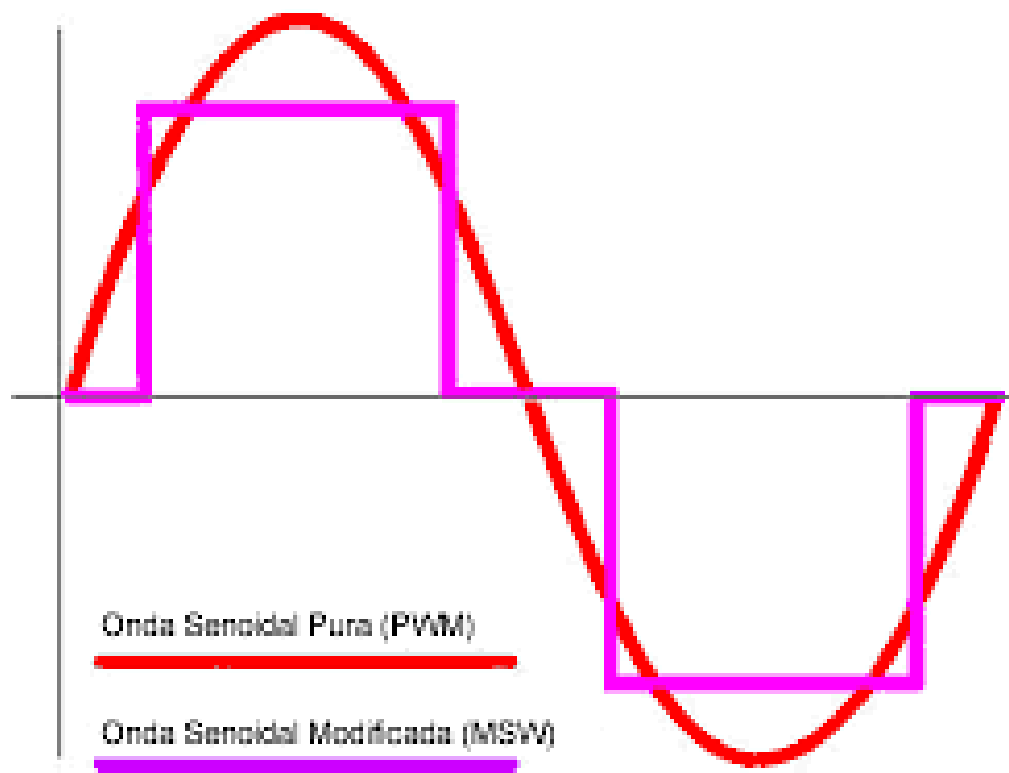

Onda cuadrada

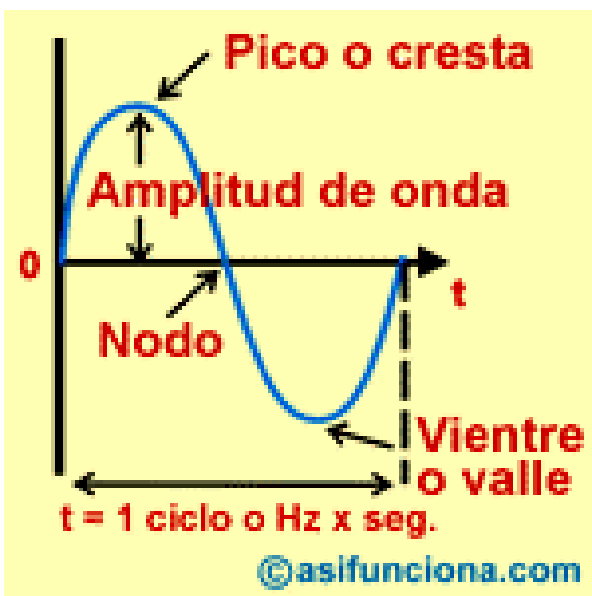

BASIC APPLICATION CIRCUIT

Fig. 2 Circuit

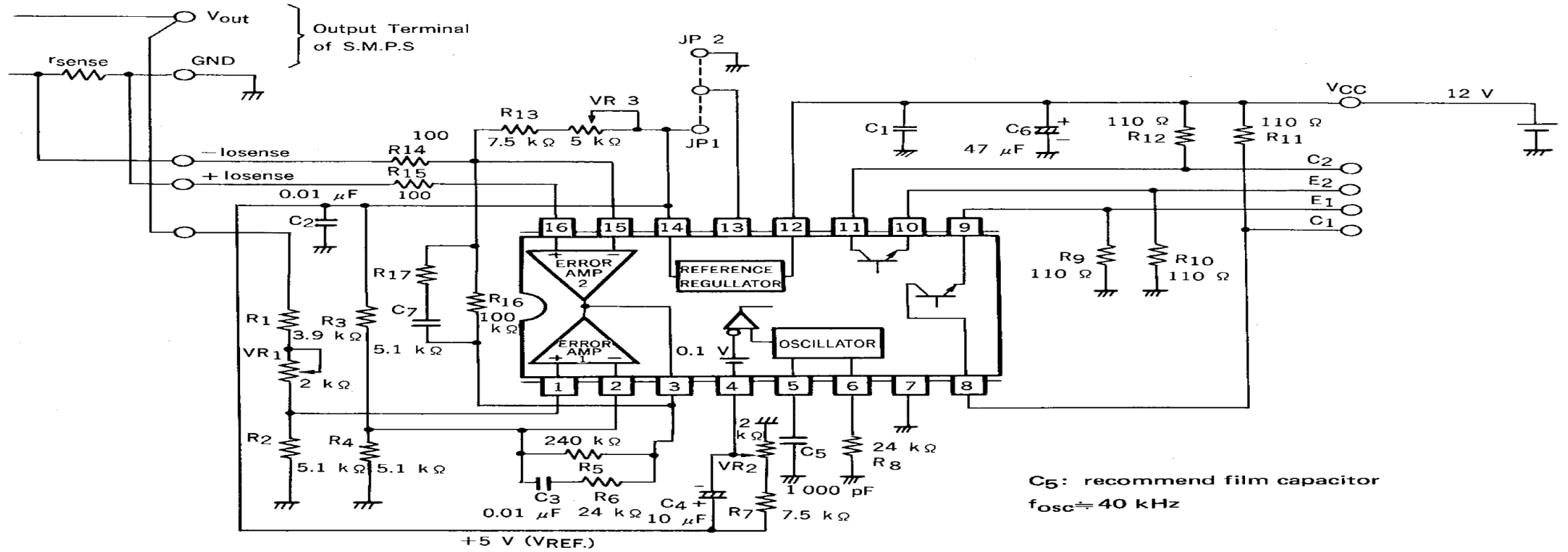

CONNECTION DIAGRAM

OUTPUT FUNCTION	OUTPUT CONTROL INPUT (13 pin)	OUTPUT MODE	OUTPUT VOLTAGE WAVEFORM
Push-Pull Operation	At Ref-Out (JP1 Wired)	Open Collector (R ₉ , R ₁₀ 0 Ω)	C1, C2
		Emitter Follower (R ₁₁ , R ₁₂ 0 Ω)	E1, E2
Single-Ended or Parallel Output	Grounded (JP2 Wired)	Open Collector (R ₉ , R ₁₀ 0 Ω)	C1, C2
		Emitter Follower (R ₁₁ , R ₁₂ 0 Ω)	E1, E2

ETAPA DE REGULACIÓN OSCILACIÓN

- 1-COMPUERTA
- 2-DRENAJE
- 3-FUENTE

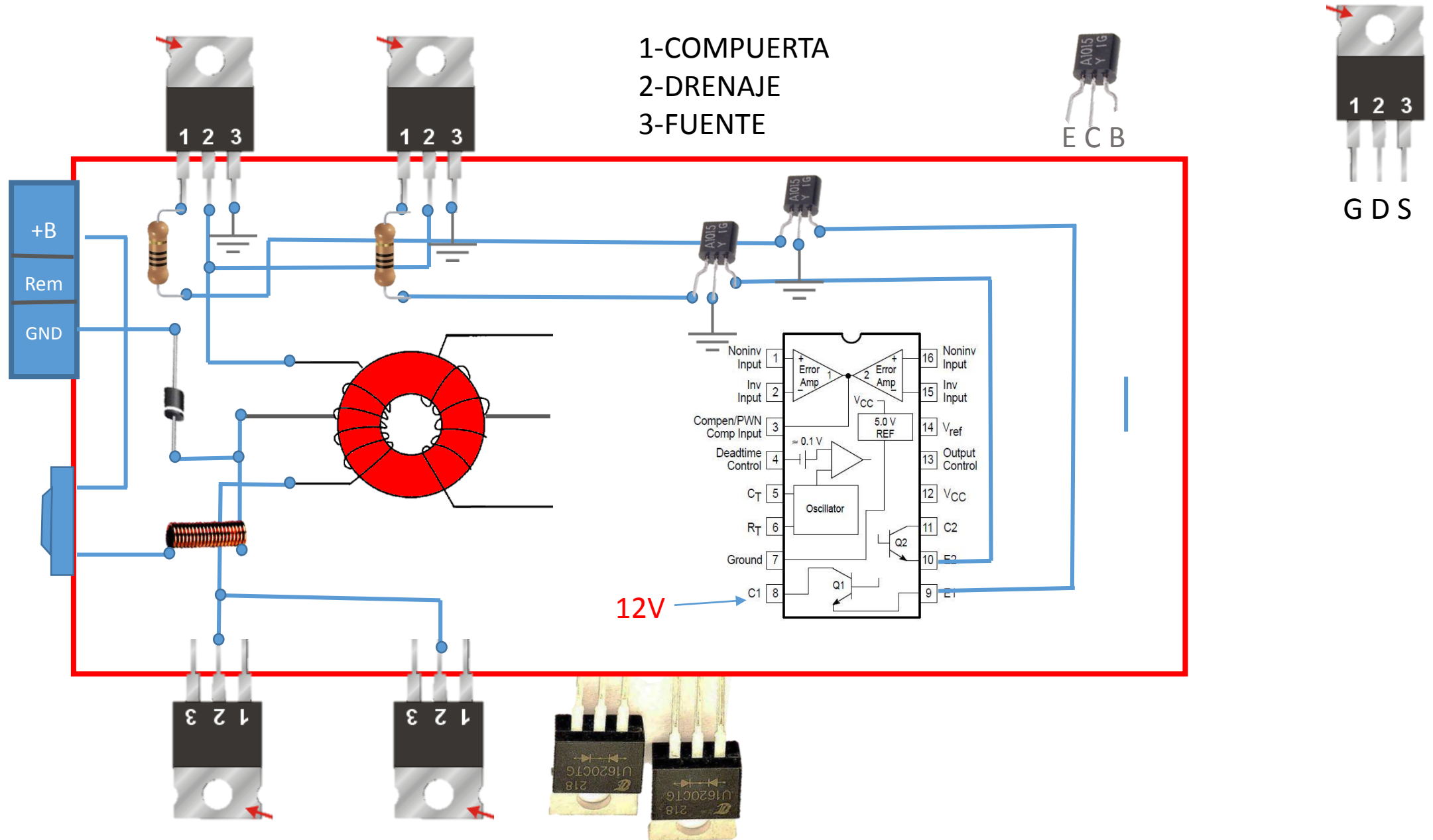

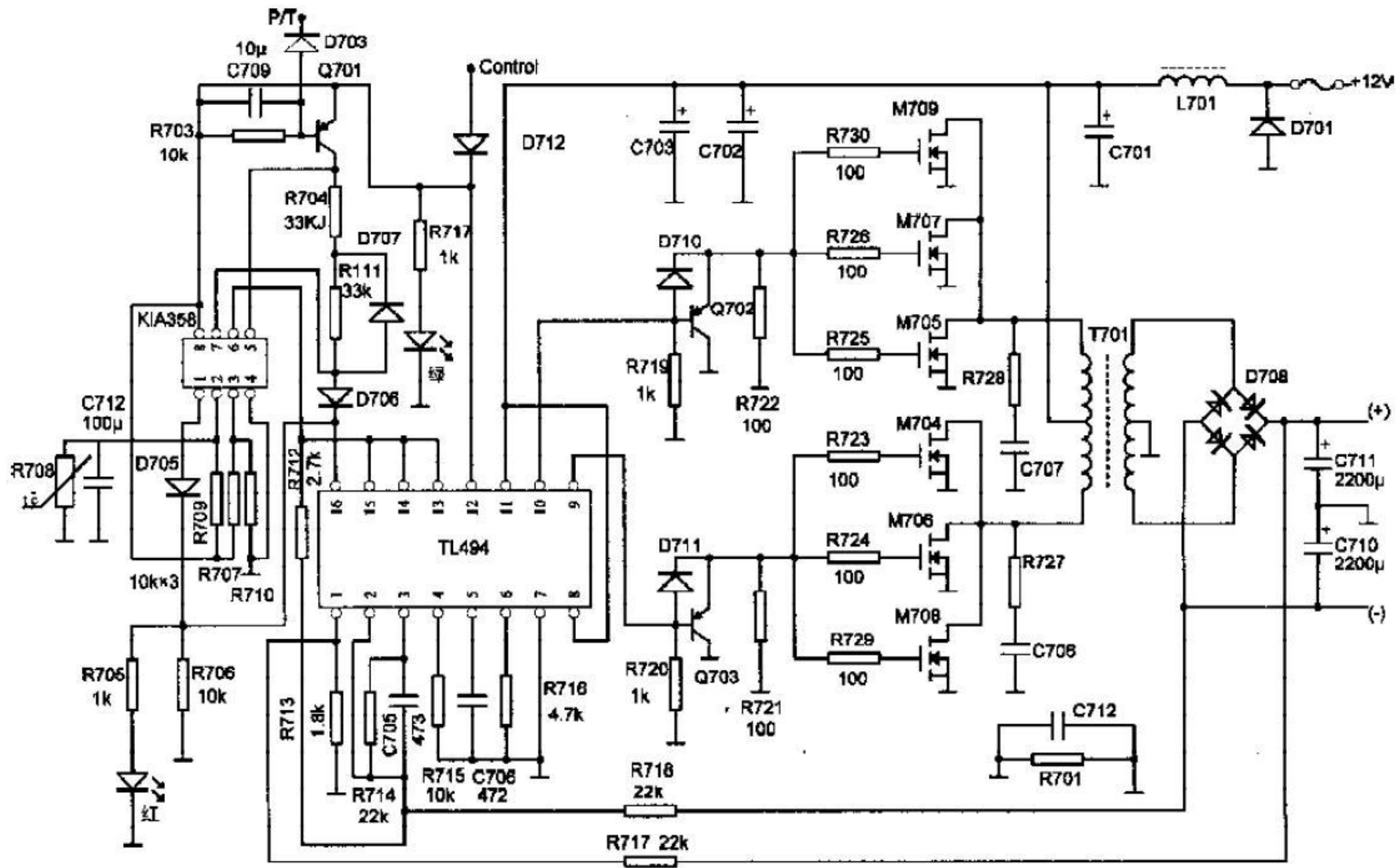

图 1